



INSTALLATION INSTRUCTIONS

MicroComm DXI

TMM-441 Touchscreen Master Module

1 Intent & Scope

This document describes the installation procedures for the TMM-441 Touchscreen Master Module.

2 Description

The TMM-441 is a desktop unit consisting of a speaker, a gooseneck electret microphone, a push-to-talk (PTT) switch, and a rotary knob volume control. The TMM-441 supports headset, handset and handsfree operation. The TMM-441 operates as a half-duplex device when in the handsfree mode and as a full-duplex device in handset or headset mode. When the handset is off-hook it operates as the sole communications device, when the handset is on-hook either handsfree or headset operation is possible. When the headset is plugged in handsfree operation is disabled.

In handsfree operation a microphone line level input/output is available for connecting a third party external feedback suppressor for eliminating undesirable feedback from overhead paging speakers. The TMM-441 has provisions to connect an external PTT switch.

The unit is designed to connect to channels 16 and Master Mic of the SAB-300, SAB-400 and SAB-401, to any two adjacent channels on an SAB-400 or SAB-401, or to the master port of a DXL DCC or DCE. The TMM is connected via a cable with a female DB-9 plug on the end that connects to the unit.

The TMM-441 has a 6-pin female RJ-25 jack located on the back of the unit that can be used to connect a handset. It also has a 3.5 mm stereo jack that provides line level output for external amplifier/speaker connections. When a plug is inserted into the jack the audio to the built in speaker is disconnected.

The jack and connector locations on a TMM-441 are shown in the following diagram.

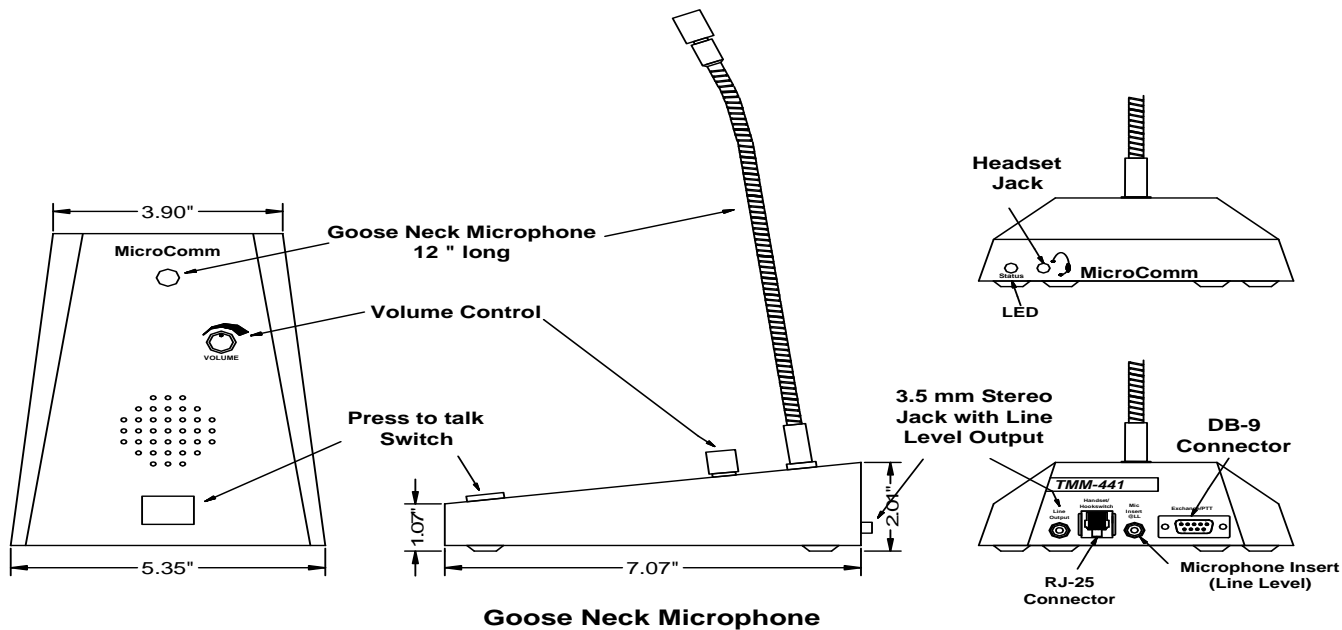

Figure 1. TMM-441

3 Connecting the TMM-441 to a DCC or DCE

The following diagram gives an overview of the wiring required to connect a TMM-441 to the master port of a DCC (or DCE). The TMM to junction box cable (user supplied) is terminated with a female DB-9 connector at one end that mates to the male DB-9 located on the TMM-441. The wires at the other end of the cable are connected to a user supplied junction box located near the TMM.

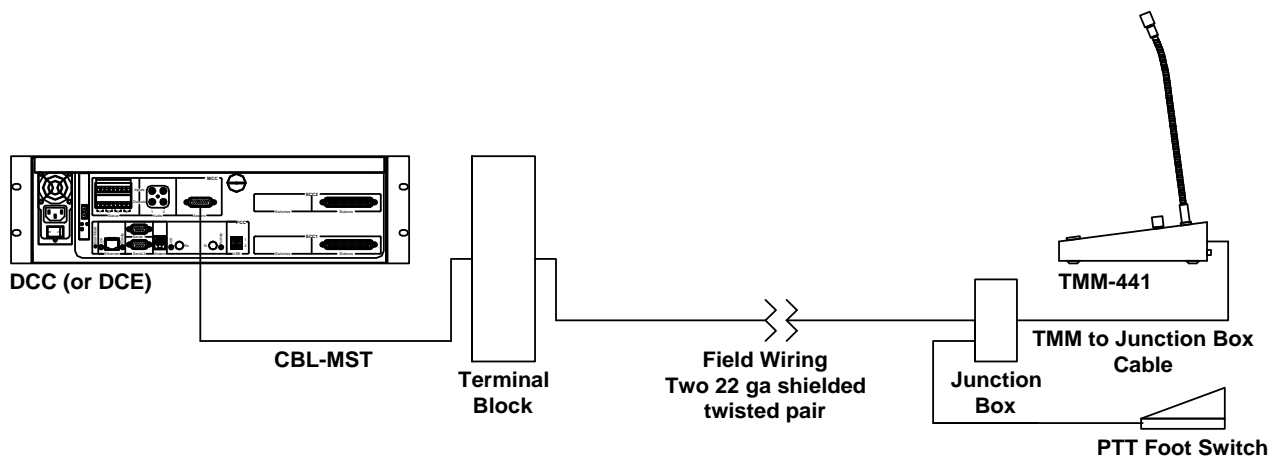

Figure 2. Overview of Wiring Connecting for a TMM-441

The TMM-441 male DB-9 connector is used to provide connections to an external PTT and to the microphone and speaker channels for audio communications to a DXL or DXI system.



Figure 3. Male and Female DB-9 Connector

The following table gives the pin assignments for the DB-9 connector.

Pin	Function
1	Gnd
6	Gnd
2	nc
7	PTT-
3	PTT+
8	Spk-
4	Spk+
9	Mic-
5	Mic+

Table 1 DB-9 Pin Connections

3.1 Connecting to a DXL DCC or DCE master port

A cable with a female DB-9 connector must be made up to mate with the male DB-9 connector on the TMM and connect DB-9 pins to a junction box located near the TMM-441. The cable consists of two 22 ga shielded twisted pair (audio cables) and one 22 gauge unshielded twisted pair (for the PTT switch). The shields are left unconnected at the DB-9 connector but are connected to the shields of the corresponding field wiring cables that originate at the terminal block and terminate at the junction box. The shields are then grounded at the terminal block. The terminal block is connected via a CBL-MST cable to a DCC or DCE master port. The master port DB-15 pins and cable wire colors are given in the following table. The signal pairs labeled Master 1 Mic and Master 1 Spk are used to connect to a TMM. Depending on the MCC configuration the Master 2 Mic and Master 2 Spk connections can also be used. If the unit has been ordered for one IMS/TMM master and one TSM master the IMS/TMM master is connected to the signals labeled Master 1 and the TSM master is connected to the signals labeled Master 2.

The mic and speaker polarity from the TMM to the DCC (or DCE) must be maintained. The external PTT switch is connected to the unshielded twisted pair at the junction box.

Note: when connecting an IMS master the Spk and Mic connections are polarity sensitive.

DB-15	Signal	CBL-MST Wire Color	Terminal Block Pin Number
1	Master 1 Mic+	Red	
9	Master 1 Mic-	Black	
2	Gnd	Red/Black Shield & White/Black Shield	
10	Master 1 Tip	White	
3	Master 1 Ring	Black	
11	Master 1 Spk+	Green	
4	Master 1 Spk -	Black	
12	Gnd	Green/Black Shield & Blue/Black Shield	
5	Master 2 Spk-	Black	
13	Master 2 Spk+	Blue	
6	Master 2 Ring	Black	
14	Master 2 Tip	Yellow	
7	Gnd	Yellow/Black Shield & Brown/Black Shield	
15	Master 2 Mic-	Black	
8	Master 2 Mic+	Brown	

Table 2 Pin Numbers and Wire Color for CBL-MST cable

3.2 Connecting to a DXI SAB-400 or SAB-401

The Station Audio Board SAB-400 or SAB-401 uses a female DB-37 connector to interface to the external audio lines. Three different factory manufactured cables can be used to connect the audio lines of the SAB-400 or SAB-401 to the field wiring.

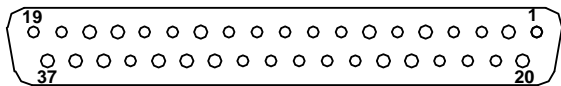

Female DB-37 Connector

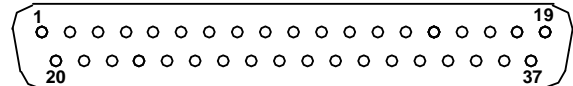

Male DB-37 Connector

3.2.1 CBL -196 cable and QCB-120

A double ended CBL-196 cable can be used to connect the audio lines from the SAB 400/401 to the field wiring via a Quick Connect Board (QCB-120). A quick release male connector at one end connects to the SAB and a screw lock male DB-37 connects to the QCB. The Spk+ and Spk - pins are connected to an SAB Audio 16 pair and the Microphone pair is connected to the Master Mic pair. The TMM audio lines can also be connected to any adjacent pair of ports on an SAB-400 or SAB-401 (1-2, 2-3, 3-4, ... 15-16) with the Speaker pair connected to the first SAB-400 (SAB-401) audio port, the Microphone pair connected to the second SAB-400 (SAB-401).

3.2.2 CBL-190 cable

A second method of connecting the audio lines of a SAB-400/401 is to use a CBL-190 cable to interface the audio inputs to the field wiring via a terminal block. The CBL-190 incorporates 17 individual pairs with a male DB-37 connector on one end (one of the pairs provides ground connection from the SAB-400 or SAB-401 to the terminal block).

Table 3 gives the pin numbers, wire colors, and suggested terminal block position for each of the station audio board signals when a CBL-190 audio cable is used. The Spk+ and Spk - pins are connected to the SAB Audio 16 pair and the Microphone pair is connected to the Master Mic pair. The shields should be left open at the TMM but

connected to the power supply ground at the SAB. The shields are connected together on pin 37 (ground). The TMM audio lines can also be connected to any adjacent pair of ports on an SAB-400 or SAB-401 (1-2, 2-3, 3-4, ... 15-16) with the Speaker pair connected to the first SAB-400 (SAB-401) audio port, the Microphone pair connected to the second SAB-400 (SAB-401) audio port, and the shields connected to the individual shield terminals. Proper polarity of the wiring from the SAB to the TMM must be maintained. The wire colors are given for each of the two different cable types that may be used.

3.2.3 CBL-195 cable

A third method of connecting the audio lines of a SAB-400/401 is to use a CBL-195 cable to interface the audio lines of the SAB to the field wiring via a 50 pin pre-manufactured terminal block. The double ended CBL-195 cable has a male DB-37 connector at one end to mate to the station card and a screw lock male DB-50 connector at the other end to mate to the pre-manufactured terminal bloc. Table 3 gives the pin numbers and terminal block position for each of the station audio board signals when a CBL-195 audio cable is used (The column with wire colors does not apply). The field wiring connects the TMM Spk+ and Spk - pins to the SAB Audio 16 pair and the Microphone pair is connected to the Master Mic pair. The shields should be left open at the TMM but connected to the power supply ground at the SAB. The shields are connected together on pin 37 (ground). The TMM audio lines can also be connected to any adjacent pair of ports on an SAB-400 or SAB-401 (1-2, 2-3, 3-4, ... 15-16) with the Speaker pair connected to the first SAB-400 (SAB-401) audio port, the Microphone pair connected to the second SAB-400 (SAB-401) audio port, and the shields connected to the individual shield terminals. Proper polarity of the wiring from the SAB to the TMM must be maintained.

TMM-441 Touchscreen Master Module

Wiring Table for Generic Terminal Block

DB37 Pin Number	Signal	SAB Cable Wire Color Provo 12110 18 Pair	SAB Cable Wire Color Belden Standard 19 Pair	Terminal Block Pin Number	
1	Audio 1 +	Blue	Black	1	
20	Audio 1 -	White	Red	2	
	Gnd			3	Audio Shield 1
2	Audio 2 +	Orange	Black	4	
21	Audio 2 -	White	White	5	
	Gnd			6	Audio Shield 2
3	Audio 3 +	Green	Black	7	
22	Audio 3 -	White	Green	8	
	Gnd			9	Audio Shield 3
4	Audio 4 +	Brown	Black	10	
23	Audio 4 -	White	Blue	11	
	Gnd			12	Audio Shield 4
5	Audio 5 +	Slate	Black	13	
24	Audio 5 -	White	Yellow	14	
	Gnd			15	Audio Shield 5
6	Audio 6 +	Blue	Black	16	
25	Audio 6 -	Red	Brown	17	
	Gnd			18	Audio Shield 6
7	Audio 7 +	Orange	Black	19	
26	Audio 7 -	Red	Orange	20	
	Gnd			21	Audio Shield 7
8	Audio 8 +	Green	Red	22	
27	Audio 8 -	Red	White	23	
	Gnd			24	Audio Shield 8
9	Audio 9 +	Brown	Red	25	
28	Audio 9 -	Red	Green	26	
	Gnd			27	Audio Shield 9
10	Audio 10 +	Slate	Red	28	
29	Audio 10 -	Red	Blue	29	
	Gnd			30	Audio Shield 10
11	Audio 11 +	Blue	Red	31	
30	Audio 11 -	Black	Yellow	32	
	Gnd			33	Audio Shield 11
12	Audio 12 +	Orange	Red	34	
31	Audio 12 -	Black	Brown	35	
	Gnd			36	Audio Shield 12
13	Audio 13 +	Green	Red	37	
32	Audio 13 -	Black	Orange	38	
	Gnd			39	Audio Shield 13
14	Audio 14 +	Brown	Green	40	
33	Audio 14 -	Black	White	41	
	Gnd			42	Audio Shield 14
15	Audio 15 +	Slate	Green	43	
34	Audio 15 -	Black	Blue	44	
18	Gnd	* Green	* Green	45	Audio Shield 15
16	Audio 16 +	Blue	Green	46	
35	Audio 16 -	Yellow	Yellow	47	
37	Gnd	* Yellow	* Orange	48	Audio 16 & Mic Shield
17	Master Audio Mic +	Orange	Green	49	
36	Master Audio Mic -	Yellow	Brown	50	

*Ground wire pair. All wiring is polarity sensitive. Pin 19 is also ground.

Table 3 Wire Color and Terminal Block pin numbers for CBL-190 and CBL-195

3.3 Connecting to an SAB-300

For Station Audio Board SAB-300 with assembly numbers of ASM-4671002-1 or higher a TMM-441 can be connected to the Audio Pair 16 and the Mic pair.

3.3.1 CBL-136 cable and QCB

A CBL-136 cable and a Quick Connect Board (QCB-120) can be used to connect the audio lines to the external field wiring. The CBL 136 double ended cable has a quick release male DB-50 connector at one end to mate to the SAB-300 and a screw lock male DB-37 connector to mate to the QCB.

3.3.2 CBL-130 cable

A second method of connecting to the field wiring via a terminal block is to use a CBL-130 cable. The CBL-130 cable has a male DB-50 connector to mate to SAB-300. It incorporates 17 individual shielded pairs that can be terminated on a 50 pin terminal block,

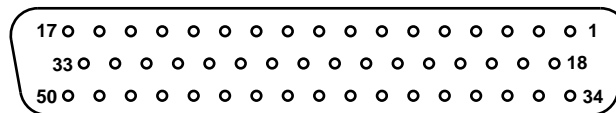

Female DB-50 Connector

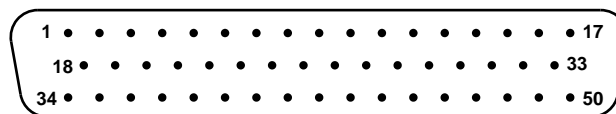

Male DB-50 Connector

The CBL-130 audio cable male DB-50 connector mates to the female DB-50 connector on the SAB-300. Table 4 gives the pin numbers, wire colors, and terminal block position for each of the station audio board signals when a CBL-130 audio cable is used. The cable can be terminated on the terminal block in the fashion shown.

The field wiring from the TMM Spk+ and Spk - pins connects to the SAB-300 Audio 16 pair and the TMM Mic+ and Mic- pins are connected to the SAB Master Mic pair.

3.3.3 CBL-135 cable

A third method of connecting the audio lines of a SAB-300 is to use a CBL-135 cable to interface the audio lines of the SAB to the field wiring via a 50 pin pre-manufactured terminal block. The double ended CBL-135 cable has a male DB-50 connector at one end to mate to the station card and a screw lock male DB-50 connector at the other end to mate to the pre-manufactured terminal block. Table 4 gives the pin numbers and terminal block position for each of the station audio board signals when a CBL-135 audio cable is used (The column with wire colors does not apply). The TMM Spk+ and Spk - pair is connected to the SAB Audio 16 pair and the TMM Microphone pair is connected to the Master Mic pair. The shields should be left open at the TMM but connected to the power supply ground at the SAB. Proper polarity of the wiring from the SAB to the TMM must be maintained.

TMM-441 Touchscreen Master Module

Wiring Table for Generic Terminal Blocks

DB50 Pin Number	Signal	SAB Cable Wire Color (for CBL-130 cable)	Terminal Block Pin Number
1	Audio 1 +	Black	1
18	Audio 1 -	Red	2
34	Audio 1 Shield	BR Shield	3
2	Audio 2 +	Black	4
19	Audio 2 -	White	5
35	Audio 2 Shield	BW Shield	6
3	Audio 3 +	Black	7
20	Audio 3 -	Green	8
36	Audio 3 Shield	BG Shield	9
4	Audio 4 +	Black	10
21	Audio 4 -	Blue	11
37	Audio 4 Shield	BBI Shield	12
5	Audio 5 +	Black	13
22	Audio 5 -	Yellow	14
38	Audio 5 Shield	BY Shield	15
6	Audio 6 +	Black	16
23	Audio 6 -	Brown	17
39	Audio 6 Shield	BBr Shield	18
7	Audio 7 +	Black	19
24	Audio 7 -	Orange	20
40	Audio 7 Shield	BO Shield	21
8	Audio 8 +	Red	22
25	Audio 8 -	White	23
41	Audio 8 Shield	RW Shield	24
9	Audio 9 +	Red	25
26	Audio 9 -	Green	26
42	Audio 9 Shield	RG Shield	27
10	Audio 10 +	Red	28
27	Audio 10 -	Blue	29
43	Audio 10 Shield	RBI Shield	30
11	Audio 11 +	Red	31
28	Audio 11 -	Yellow	32
44	Audio 11 Shield	RY Shield	33
12	Audio 12 +	Red	34
29	Audio 12 -	Brown	35
45	Audio 12 Shield	RBr Shield	36
13	Audio 13 +	Red	37
30	Audio 13 -	Orange	38
46	Audio 13 Shield	RO Shield	39
14	Audio 14 +	Green	40
31	Audio 14 -	White	41
47	Audio 14 Shield	GW Shield	42
15	Audio 15 +	Green	43
32	Audio 15 -	Blue	44
48	Audio 15 Shield	GBI Shield	45
16	Audio 16 +	Green	46
33	Audio 16 -	Yellow	47
49	Audio 16 & 17 Shield	GY Shield & GBr Shield	48
17	Master Mic Audio +	Green	49
50	Master Mic Audio -	Brown	50

Master (Audio 16 and Master Mic) wiring is polarity sensitive.

Table 4 Wire colors and terminal block pin numbers for CBL-130 and CBL-135 cables

4 Handset/Hookset Installation

The HHK-136 Handset/Hookswitch kit facilitates a handset with hookswitch to be connected to the Touchscreen Master Module (TMM-441). The kit comes complete with the following items:

- handset with coil cord and PTT
- hookswitch cradle with four #10-32 x 0.375" mounting screws included
- coil cord strain relief
- surface mount RJ-11 wall jack with two mounting screws included
- RJ-11 patch cable

A HHK-136 kit has a handset with a hook switch that closes when the handset is off hook. The handset/hookswitch connects to the TMM-441 via a 6-pin female RJ-11 jack.

4.1 Panel Preparation

Either drill or punch the mounting holes indicated on the following diagram. Note the position shown for the handset cable strain relief is typical only and may be relocated as necessary,

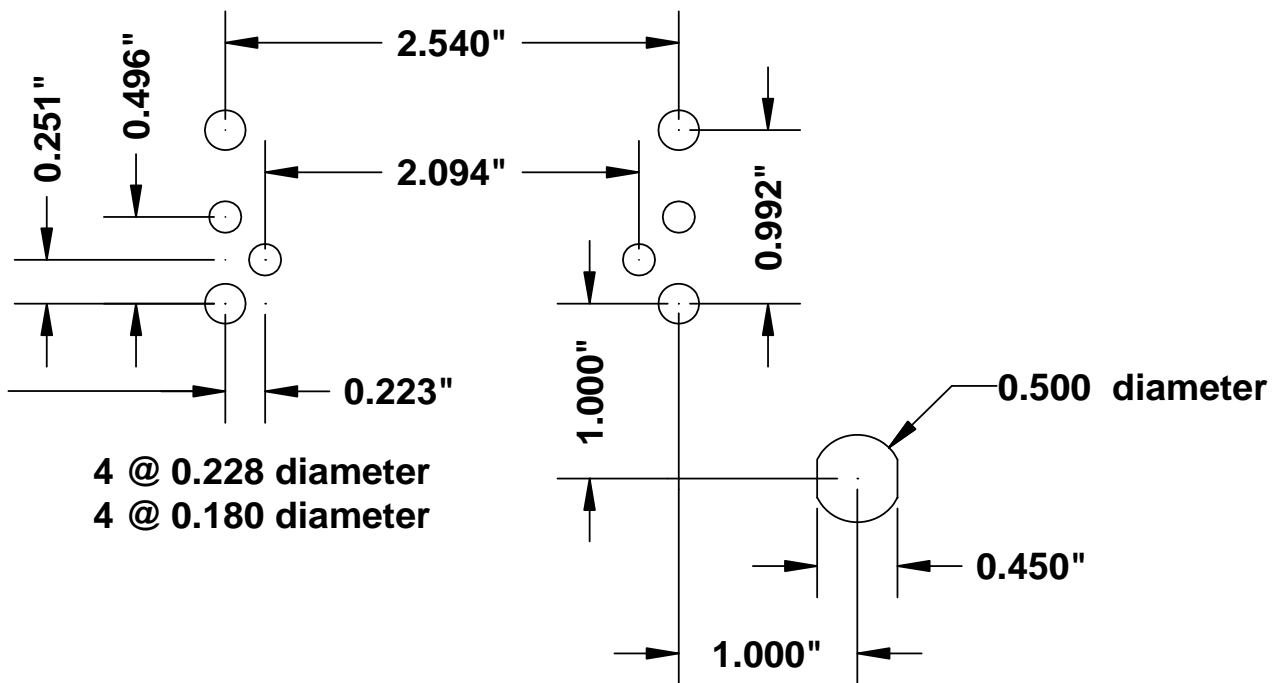

4.2 Handset Hanger Mounting

1. Feed the two (hookswitch pair) black leads from the hanger through the access hole in the panel.
2. Install the handset hanger onto the panel using the four screws provided.

4.3 Handset Cable Installation

1. Feed the six wires from the handset through the strain relief cut-out in the panel.
2. Place the strain relief onto the handset cable near the first coil in the cord and press it into the panel cut out.

4.4 Surface Mount Wall Jack (RJ-25) Installation

1. Locate a position for the RJ-25 wall jack within reach of both the handset and hookswitch wires. Remove the RJ-25 wall jack cover and using the two screws provided mount the unit. (note the screws that are supplied with the RJ-25 jack are meant to screw into a wood surface)
2. The surface mount RJ-11 can come in two configurations as shown in the following diagram. The colors indicated are the colors of the wires that run from the terminals to the RJ-25 female jack.

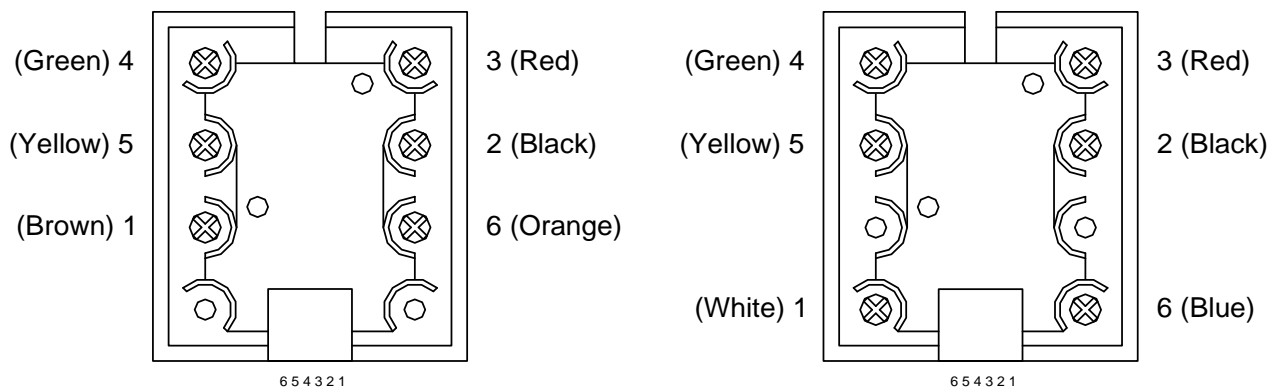

Figure 4. Surface Mount RJ-25 – Cover Removed Two Possible Configurations

4.4.1 Handset Connection

1. Connect the handset and hookswitch to terminals 1 through 6 as indicated in the diagram shown below. Note that the hookswitch (HKS), press to talk (PTT), and the Speaker (Spk) pair of wires are not polarity sensitive. The microphone (Mic) pair is Mic + and Mic - wires is polarity and the polarity of the microphone leads should be verified. as a high percentage of the handsets are incorrectly wired. On many handsets the Mic+ is normally red and the MIC- is normally black.
2. To determine the polarity use a digital multimeter and follow the procedures outlined below.
 - a. Measure the DC resistance with the first wire connected to the positive ohmmeter probe, and the other wire connected to the negative ohmmeter probe. Record the measurement.
 - b. Measure the DC resistance with the other wire connected to the positive ohmmeter probe, and the first wire connected to the negative ohmmeter probe. Record the measurement.
 - c. The measurements should differ by approximately 300-500 ohms. If the first reading is greater than the second reading the first wire is Mic+. If the first reading is less than the second reading the other wire is Mic+ Take note of the polarity for future reference and mark the Mic- with a black marker pen.

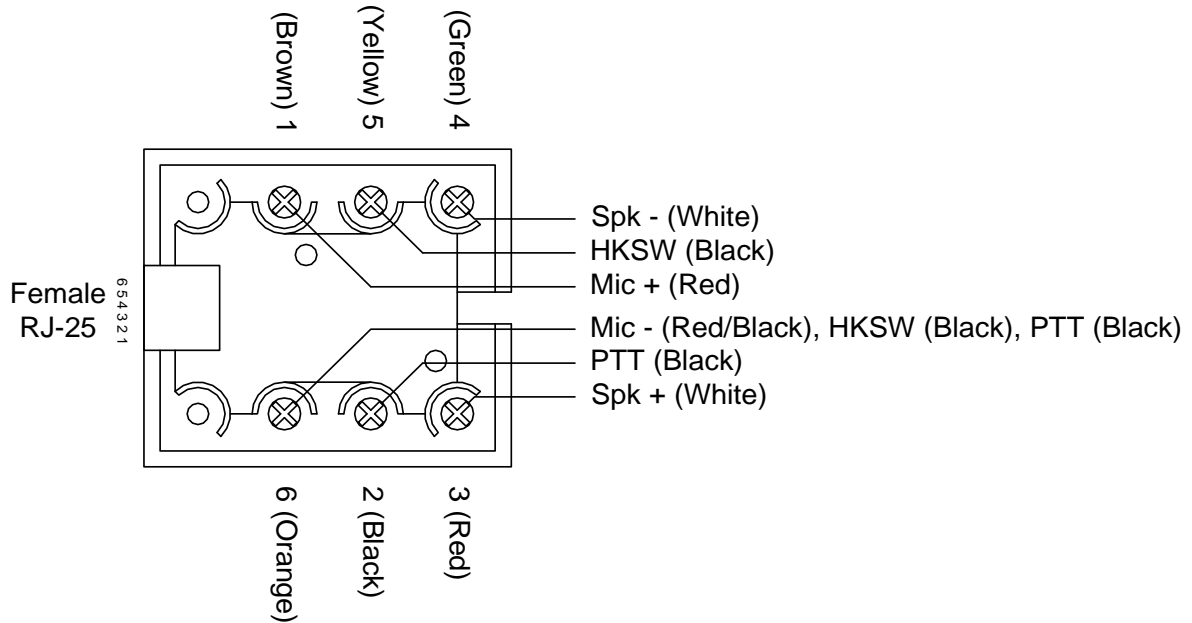

Figure 6 Handset to Surface Mount Wall Jack Wiring

The 6-pin female RJ-25 jack and pin numbers is shown in the following diagram.

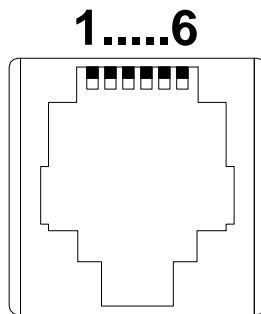

Figure 6. RJ-25 Female Jack

A 6 conductor RJ-25 patch cable is supplied with the HHK-136 Handset/Hookswitch and connects the surface mount RJ-25 wall jack and the RJ-25 connector located on the back of the TMM-441.