

# Axis<sup>AX</sup>

## Axis AX Intelligent 1, 2 & 4 Loop Fire Alarm Control Panels

The Axis AX multi-loop panel is available in three standard models: the AX-CTL-1L (1 loop), AX-CTL-2 (2 loop) and AX-CTL-4 (4 loop). Designed with installation and service engineers in mind, these intelligent panels are modularly packaged, using surface mount and dual flash microprocessor technology, with onboard real-time clocks for ease of installation, troubleshooting, programming and maintenance.

The AX-CTL-1L provides one Style 4 or Style 6/7 signalling line circuit, whilst the AX-CTL-2 provides two Class X, A or B signalling line circuits (SLCs) and the AX-CTL-4 provides four Class X, A or B signalling line circuits (SLCs). Communication to field devices attached to the SLCs is via an advanced, 100% digital protocol which has the advantages of being highly immune to noisy environments and the ability to operate over non-shielded cable without causing interference problems with sensitive electronic equipment.

Each SLC supports up to 126 analogue-addressable devices (any combination of intelligent detectors, input and/or output devices, including loop-powered technology devices). In addition, our unique sub-addressing of various input and/or output devices permits further system expansion.

The AX-CTL-1L and AX-CTL-2 come with two filtered, voltage-regulated notification appliance circuits (NACs), Class A or B, each rated 2 Amp @ 24 VDC. The onboard NAC outputs provide compatibility with most listed notification appliances.

The AX-CTL-4 fire panel provides four signalling line circuits (SLCs) and four fully filtered, voltage-regulated notification appliance circuits (NACs), each rated 2 Amp @ 24 VDC. In this configuration, the Axis AX panel can accommodate a total system capacity of 504 analogue addressable points as standard, not counting sub-addressing capacity.

The AX-CTL-1L, AX-CTL-2 and AX-CTL-4 panels have resettable and non-resettable power outputs, each rated 0.5 Amp @ 24 VDC, for connection to four-wire conventional smoke detectors and/or ancillary devices. Each AX-CTL-2 and AX-CTL-4 contains three field-programmable Form "C" relays, each rated 1 Amp @ 30 VDC, defaulted as a fail-safe trouble relay, alarm relay and supervisory relay.



### Features

- Advanced user interface with graphical LCD
- Multi-pattern & two-stage NAC control
- Remote diagnostic capabilities
- Advanced networking - up to 200 FACP
- Built-in intelligent multi-meter
- Up to 504 analogue-addressable points
- Automatic drift compensation per detector
- Automatic detector testing with maintenance alert
- Alarm verification and PAS
- Class X, A or B SLC operation (supports loop-powered technology)
- Synchronisation of audibles and visuals (panel or network wide)
- User-friendly PC-NeT field configuration program
- 5 to 10 Amps of system power

Simplifying and reducing initial system set-up, each Axis AX intelligent fire alarm control panel is equipped with an installer-friendly “auto-learn/loop detection” feature that permits the rapid recognition of all signalling line circuits’ devices. This rapid recognition simplifies the immediate assignment of critical life safety functions. Assignments include intelligent detector type and operation criteria, addressable input device recognition as an alarm input, and addressable output control on a general alarm basis.

Designed with powerful built-in installation and customisation tools, Axis AX fire panels can adapt to virtually any application requirement. With Dynamix I/O programming, typical time-consuming complexities associated with I/O relationship programming such as two-stage multi-pattern NAC control, intelligent detector drift compensation, precision response/sensitivity mode settings and flexible timing functions are significantly reduced.

Axis AX fire control panels are fully field-programmable via the onboard graphical LCD display and alphanumeric keypad. Front-panel programming may encompass defining input to output relationships, configuring output circuit characteristics, entering zone, device and other text descriptions, and configuring multiple user-access passwords.

To maximise capability and flexibility, the Advanced Windows-based PC-NeT field configuration tool is a powerful, user-friendly programming tool that allows users to perform virtually any I/O relationship with multiple criteria. Project commissioning and troubleshooting is fast and efficient thanks to simple dropdown menus with point-and-click operation.

The Axis AX system accommodates remote graphical LCD annunciators (with or without system control capabilities) on the Advanced network. Multiple annunciator locations can be created based on installation demands. These locations can have either: no system control, partial system control or full system control. Information on system status changes can be vectored, allowing displays to receive information on specific events only.

Axis AX panels can accommodate large, sophisticated applications with relative ease. When installations exceed a single panel’s capacity, the Advanced Ad-NeT-Plus peer-to-peer network may be implemented, providing up to 200 network nodes. The network is completely field programmable for inter-panel functionality or segregation of information and control, based on the overall installation requirements.

## Features (continued)

- “Auto-learn/loop detection” programming
- Class A or B NAC circuits
- Voltage-regulated NACs (compatible with most listed NAC devices)

## Listings and Approvals







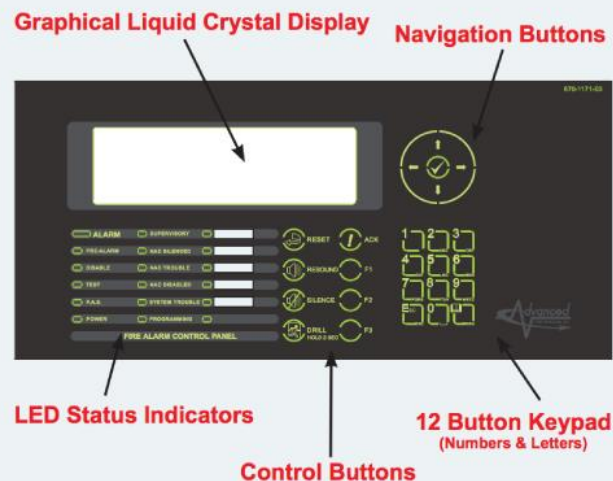

- Certified to UL864 10th Edition – File No. S35979
- CSFM Approved: Pending
- NYCFC COA: Pending

### Advanced User Interface w/Graphical LCD:

Designed to be user-friendly and easy to operate, the Advanced User Interface w/Graphical LCD (backlit 240 x 64) is the information and control center for the AX Series Intelligent Fire Alarm Control Panel(s).

The unit incorporates a graphical LCD display, LED status indicators, control buttons (including 3 programmable buttons), navigation buttons, and a 12 button keypad for complete system status, interrogation, and control.



Button (Keys)	
	Reset
	Ack (panel buzzer acknowledge)
	Resound (resound signals)
	Silence (silence signals)
	Fire Drill
	Function Keys (3 - programmable control buttons)
	Navigation Keys (up, down, left, right, and tick [enter])
	12 Button Keypad (numbers, letters, esc, and menu)

LED Indicators	
Alarm	Red
Pre-Alarm	Red
Disable	Yellow
Test	Yellow
P.A.S.	Yellow
Power	Green
Supervisory	Yellow
NAC Silenced	Yellow
NAC Trouble	Yellow
NAC Disabled	Yellow
System Trouble	Yellow
Programming	Yellow
Programmable LED 1	Red
Programmable LEDs 2-5	Yellow

Designed with the technician in mind, each module of an Axis AX panel is easy to install and service. The integral power supply offers status LEDs, temperature-compensated charging and the ability to operate directly from the batteries when AC supply is not yet available at the installation site.

A unique built-in intelligent multi-meter allows technicians to interrogate any input and/or output and diagnose potentially time-consuming issues. Servicing after installation can be as simple as using the Advanced remote diagnostic virtual panel simulator. The simulator can be activated from any Windows-based PC and connected to the installation site via a dedicated modem. It emulates the on-site control panel LCD and keypad in real time from an off-site location, and is an incredibly powerful tool for diagnosing and troubleshooting site applications.

## Wiring Diagram

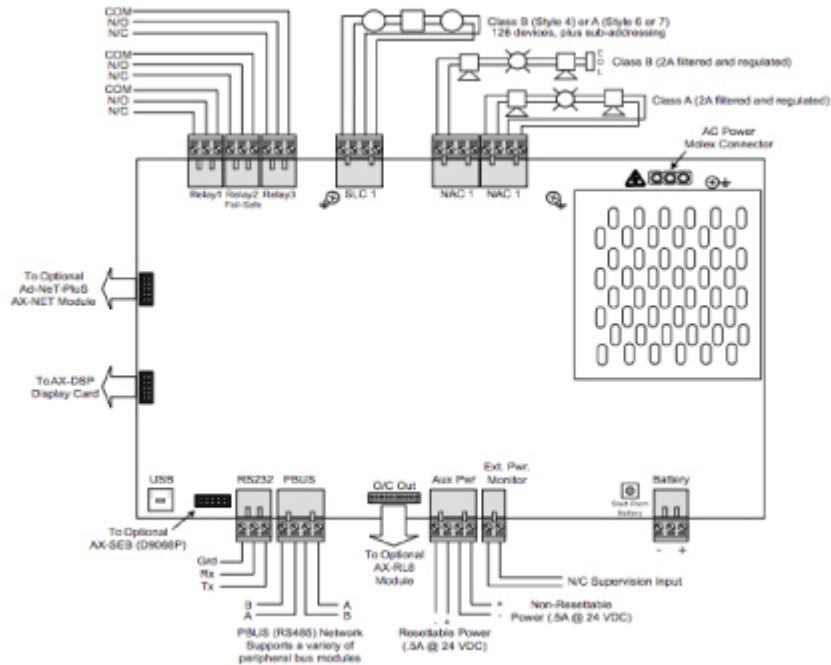

## Specification

Operating Voltage	120 VAC (1.4A) - 240 VAC (0.7A), 50/60Hz	
System-Brown-Out	98 VAC Nominal	
Battery Circuit		
Charging Voltage	27.4 VDC Nominal*	
Temp. Compensated Charging Current	2.3 Amp	
Battery Derating Factor	0.83A	
Battery Capacity	7Ah (Minimum), 75Ah (Maximum)	
Battery Fuse	10A @ 240 VAC, Time Delayed, Ceramic, High Breaking (In-line WireLink)	
Fire, Supervisory, and Trouble Relays	(Power Limited - When utilizing system power)	
Type	Form "C"	
Rating	1A @ 30 VDC/VAC	
Trouble Relay	Normally Active (Fail-safe operation)	
Auxiliary Power Outputs	(Power Limited)	
Resettable		
Voltage	24 VDC	
Current	0.5A	
Reset Time	10-15 Seconds	
Non-Resettable		
Voltage	24 VDC	
Current	0.5A	
Humidity	85% Relative Humidity	
Temperatures		
Operating	32°F - 120°F (0°C - 49°C)	
Recommended Room	60°F - 86°F (15°C - 27°C)	
Enclosure Dimensions		
Back Box	22.6"H x 14.5"W x 5.5"D	
Housing	24.1"H x 16"W x 6.3"D	
SLC Loop	(Power Limited)	
Class (Style)	Class X, A or B	
Voltage	24 VDC	
Minimum Return Voltage	17 VDC	
Current	0.5A	
NAC Circuits	(Power Limited)	
Class (Style)	Class A or B	
Voltage	24 VDC (Filtered and regulated)	
Minimum Return Voltage	16 VDC	
Current	2A (Each)	
Maximum Voltage Drop	3 VDC	
Maximum Line Impedance	1.5 Ω	
RS232		
Baud Rate	9600	
Parity	None	
Data Bits	8	
Stop Bits	1	
Base Card Operating Current	Quiescent	Alarm
AX-CTL-2	110mA	195mA
AX-CTL- 4	175mA	260mA

Refer to individual Axis AX series module data sheets for specific specifications regarding option modules

\*For use with listed/compatible product

## Order Codes and Options

AX-CTL-1L*	Intelligent Fire Alarm Control Panel with cabinet, power supply/charger, 1 SLC, 2 NACs, 3 auxiliary relays (Cabinet supports batteries 7Ah - 18Ah) (126 Addressable Points)
AX-CTL-2*	Intelligent Fire Alarm Control Panel with cabinet, power supply/charger, 2 SLCs, 2 NACs, 3 auxiliary relays (Cabinet supports batteries 7Ah - 18Ah) (254 Addressable Points)
AX-CTL-4*	Intelligent Fire Alarm Control Panel with cabinet, power supply/charger, 4 SLCs, 4 NACs, 3 auxiliary relays (Cabinet supports batteries 7Ah - 18Ah) (504 Addressable Points)
	AX-CTL Base Card Option Modules**:
AX-LPD	2 SLC, 2 NAC Expander Card
AX-NAC	2 NAC Expander Card
AX-PSU	5 Amp Expansion Power Supply Module
AX-NET4	Network Interface Card Class B
AX-NET7	Network Interface Card Class X(A)
AX-RL8	8-Way Relay Output Card (Programmable)
AX-PRN	Thermal Strip Printer
AX-UCM3	Advanced Contact-ID and SSIA Digital dialler, requires AX-SEB2
AX-SEB2	Serial Expansion Board for use with AX-UCM3

\* For the grey enclosure, add the suffix "G" to the part number

\*\* Refer to individual Axis AX Series module data sheets for peer to peer network and peripheral bus option modules.

Check if this document is up to date | Give us feedback

9564 Yellowhead Trail NW, Edmonton AB, T5G 0W4, Canada T: 1 (866) 462-7100 E: info@harding-tech.com W: www.harding-tech.com

As our policy is one of constant product improvement the right is therefore reserved to modify product specifications without prior notice.